

Assembly Manual for

# Mini-33-A

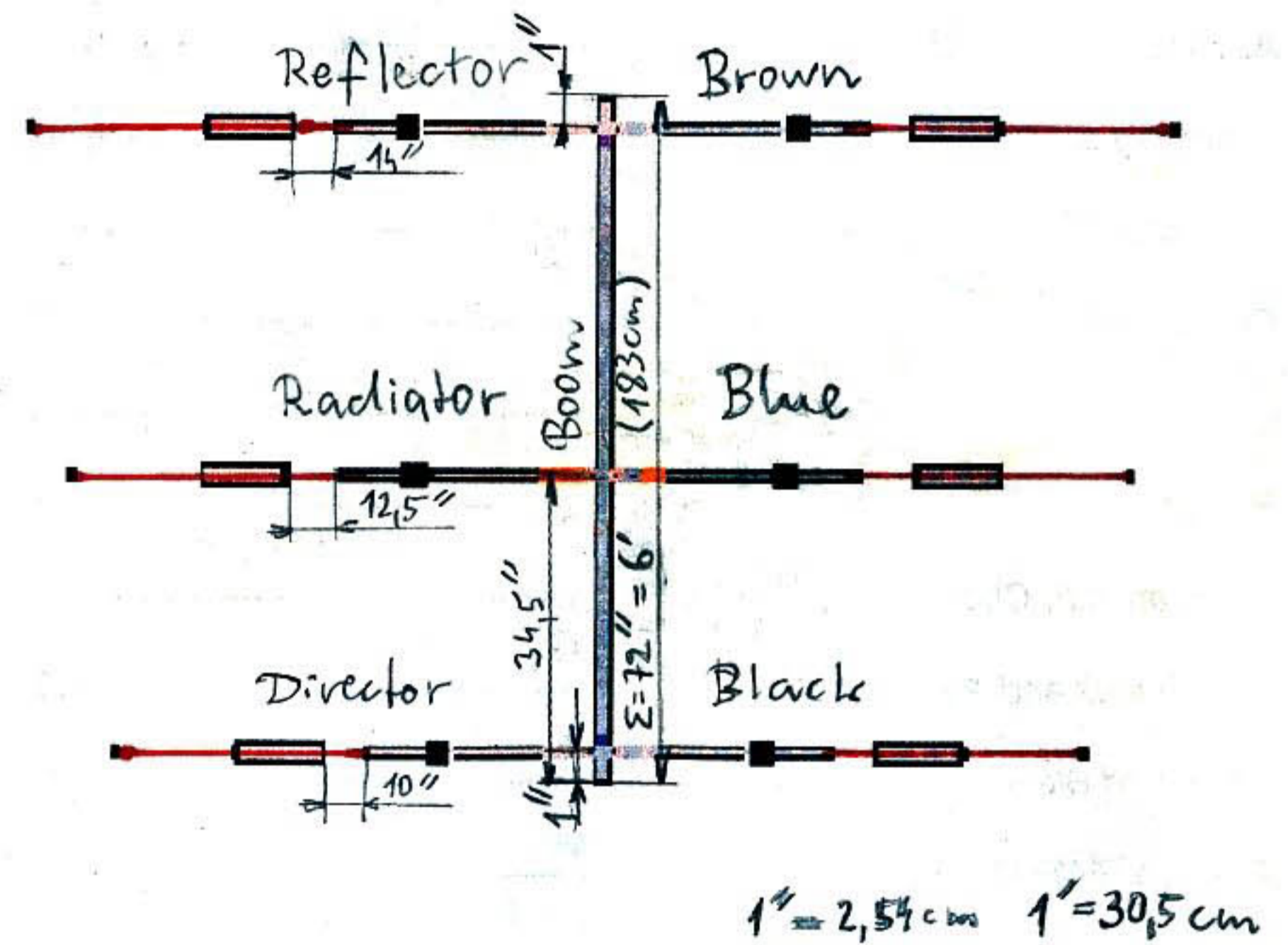

OK1MMN

Table of Contents

	PAGE #
Parts List	-----3
Deburring and Cautions	-----3
Assembly of Boom	-----4
Assembly of Mast Plate	-----4
Assembly of Driven Element	-----5
Preparing Your Coax	-----5
Placing Driven Element to Boom	-----6
Placement of Coax to Radiator	-----6
Using an R.F. Choke	-----7
Final Check and Adjustment	-----8
Notes and Blank SWR Graph	-----9
Average SWR Curves	-----10
Suggestions	-----11

Mini-33-A  
Parts List

The high performance of your Mosley Mini-33-A can only be achieved if this beam is assembled in accordance with the instructions in this manual. Substitutions of materials or modification of design will greatly lessen it's performance.

We recommend that you read through the assembly instructions and familiarize yourself with each step before assembling your antenna.

Item #	Quantity	Description
1	1	Radiator Assembly, Blue
2	1	Reflector Assembly, Brown
3	1	Director Assembly, Black
4	1	Center Radiator Assembly, Coded Blue
5	2	Trap Assembly, Coded Blue
6	2	Trap Assembly, Coded Black
8	2	Trap Assembly, Coded Brown
9	1	Small Mast Plate,
10	1	Boom, 72", Aircraft grade
11	2	Boom Caps
12	2	#41 Block, Aluminum
12a	1	#40 Block, Aluminum
13	2	#43 Clamping Block, Used on mast
13A	2	#44 Clamping Blocks, Used on boom
14	4	#8 x 5/8" S. S. Metal Screw for radiator
15	6	#6 x 3/8" S. S. Metal Screw
16	7	1-1/2" U Bolts, S. S.
17	14	1/4-20, Lock Washer
18	14	1/4" S. S. Nut
19	2	Solder Lugs
19A	2	#8 Lock Washers (For Radiator)
19B	2	8/32 Nuts (For Radiator)
20	1	Instruction Manual
21	1	Warranty Card
22	1	Deburring Notice
23	1	Warning Notice
24	1	Penatrox

**ASSEMBLY**

< > Start by grouping all element sections and traps according to color code.

**DEBURRING**

< > MAKE SURE that before attempting to sleeve ANY of the pieces of tubing together you check to see that all tubing pieces are DEBURRED!

In building the antenna we have removed the majority of the burrs, however, due to the number of pieces of tubing, the cost of labor, the time consumption; some pieces may still have a few remaining burrs. Double check the pieces before trying to put them together!

The tubing Mosley uses is made for us and the telescoping tolerances are very close. If you would try and force a piece of tubing to sleeve, which is not deburred, it will SEIZE. If this would happen, you aren't going to get them apart.

NOTE: Only install on the joints at the 5/8" and TRAPS couple. PENATROX, an anticorrosion compound, **should be applied in a light layer** between coupled sections of tubing to prevent formation of high resistance and seizing of aluminum.

**Read the "CAUTIONS"!**

- < > WHEN SECURING the traps WITH THE #6 STAINLESS SHEET METAL SCREW, DON'T OVER TIGHTEN! Seat the screw flush with the tubing and stop.
- < > CAUTION: Trap Assemblies are color coded on one end of the trap tubing. THIS COLOR-CODE MUST ALWAYS GO TOWARD THE BOOM. REVERSAL OF THE TRAPS WILL CAUSE HIGH S.W.R. AND OTHER MALFUNCTIONS.
- < > Don't overtighten the 1-1/2" U-Bolts when securing the center element assemblies to the boom. Tighten enough to seat the 1/4-20 lock washers.
- < > The MINI-33-A is an excellent antenna, however, it was designed for low power, observe the power limits of this antenna. **Do not load up in the tune position** with more than 350 watts!
- < > The various pieces of tubing used on the antenna elements are also color coded on one end. This end always goes in toward the boom.
- < > Deburr tubing and use the enclosed PENATROX.
- < > Mount All elements on TOP SIDE of Boom!
- < > Review the drawings and READ the instructions before starting assembly.
- < > Follow all safety procedures in assembly and raising of this beam. When installing the antenna, make sure the tower, all other associated hardware, and components are rated correctly for this antenna!
- < > Avoid power lines and other electrical hazards!
- < > Make sure you and the people helping you use good judgement and follow all safety rules which would apply.

**BOOM**

- < > Boom comes ready to use. Simply place the matching color coded element to the boom and secure element with a 1-1/2" U-bolt, #44 plastic clamping block, the 2, 1/4-20 lock washers, and nuts.

**ASSEMBLY AND PLACEMENT OF MAST PLATE**

- < > Place the mast plate on the boom (Part 9 ) between the (Brown) reflector and the (Blue) driven element. The mast plate will be just behind the Blue radiator and between the Brown reflector.

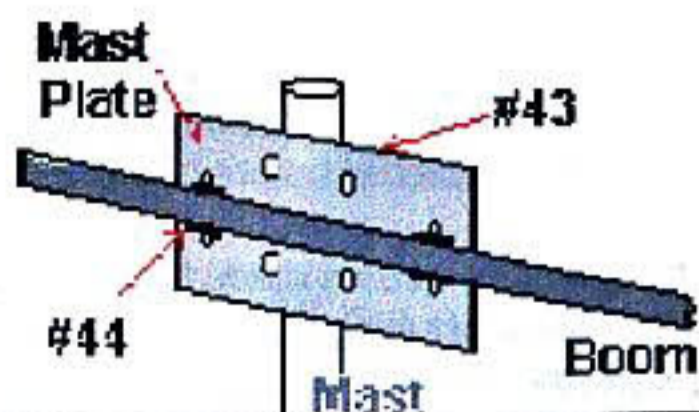

- < > Place 2, #44 clamping blocks (part 13 A) between the boom and the mast plate and secure

with the two 1-1/2" U-bolts (part 16 ).

- < > Secure the U-bolts with lock washers and nuts (parts 16, 17, 18 ).

**ASSEMBLY OF DRIVEN ELEMENT**

**Note:** In order to accommodate all the various ways and places that the Mini's are installed, we have purposely not predrilled the trapped element ends so that they can be adjusted at the installation sight. We have given a pre-selected settings, which will give a general starting point in which to work from. Tape your trapped end tips in place using a short 2" piece of tape rapped around the joint of the inner tube and the trapped element when testing the antenna. Once you have the antenna set the way you want it use the predrilled hole in the 5/8" tube as a guide hole for drilling into the 1/2" trapped end piece. **Make sure the drill used is smaller than the #6 screw which is used to secure the two element pieces.**

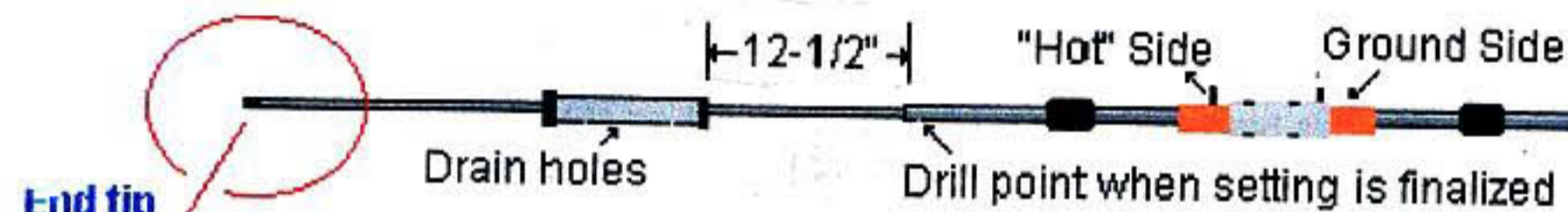

Use 12-1/2" as a starting point. This can be adjusted to give the center frequency you wish. Tape until final setting.

- < > Insert the unattached half of the **BLUE** element to the over half of the radiator. ( **Note:** Since these pieces are predrilled together the correct half should be placed on the 1/2" tube to insure that the holes align properly. Check each half to make sure they are on the correct side.) Place a light amount of the Penatrox on the exposed 1/2" tube and slide the 5/8" color coded end of the element on to the 1/2" tube. Align the two holes and secure with the 2 #8 x 3/4" stainless sheet screws. (**NOTE: Make sure that the hole at the opposite**

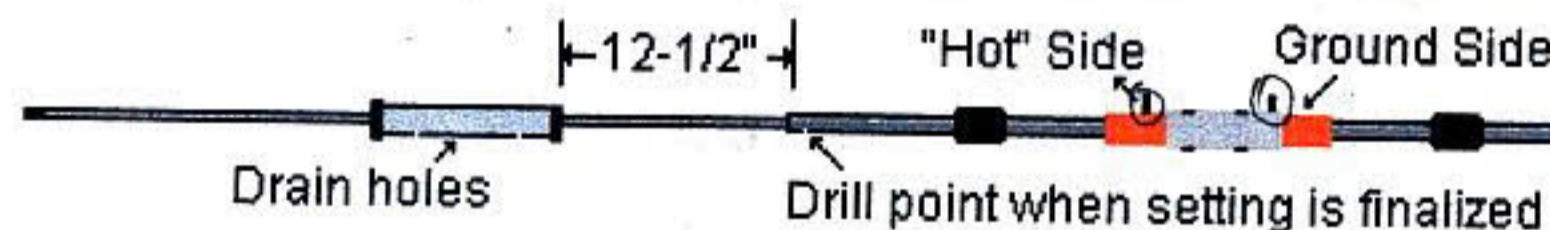

Use 12-1/2" as a starting point. This can be adjusted to give the center frequency you wish. Tape until final setting.

**end of the tube is downward. This will make sure that the trap assemblies will be mounted with their drain holes toward the ground.)**

- < > Check the element to make sure both sides of the element are correct and note that one half of the element is attached to the metal tube in the center of the element. This half of the element is the ground side of the radiator. It must have the "Braid" of the coax attach to this half of the element!
- < > Insert the color coded end of the (BLUE) trapped element. Use 12-1/2" of exposed tubing between the 5/8" tube and the trap as a starting point. See drawing.
- < > Tape into position until the remaining elements are assembled and are on the boom.
- < > Continue following the above procedure for the reflector (Brown) and the (Black) director center assemblies and trapped elements.

Assembly of the Parasitic

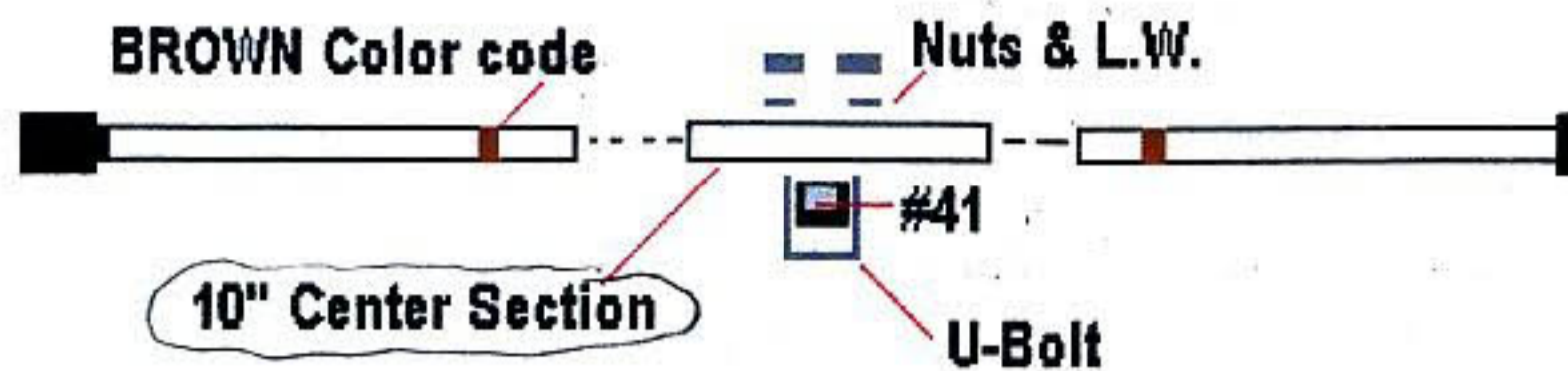

- < > Use the 10" center section of 3/4" tube and insert the color coded end of the element into the 3/4" center. See drawing.
- < > Align the hole in the element with the hole in the center section.
- < > Repeat this procedure on the opposite side making sure that the 1/2" drill holes at the outer ends are point down in the same way.
- < > Insert the same color coded traps into the exposed 5/8" inner ends.
- < > Set the BLACK color coded trap at 10" exposed on each side and tape into position.
- < > Set the BROWN color coded trap at 14" exposed on each side of the element. Secure with a small piece of tape.
- < > **DO NOT OVER TIGHTEN SCREWS OR U-BOLTS WHEN MOUNTING THE ELEMENT CENTER ASSEMBLIES! TIGHTEN DOWN ENOUGH TO COMPRESS THE LOCK WASHERS.**
- < > Place the (Blue) radiator element assembly onto the blue color cole on the boom, by using a single 1-1/2" u-bolt, lock washer and 1/4-20 nuts.

PREPARING COAX

- < > Cut insulation on coax back 3" and form the braid of the coax into a leg of the line.  
NOTE: (Make sure the leads are 3" long including the #1021 solder lug! This length is critical.)

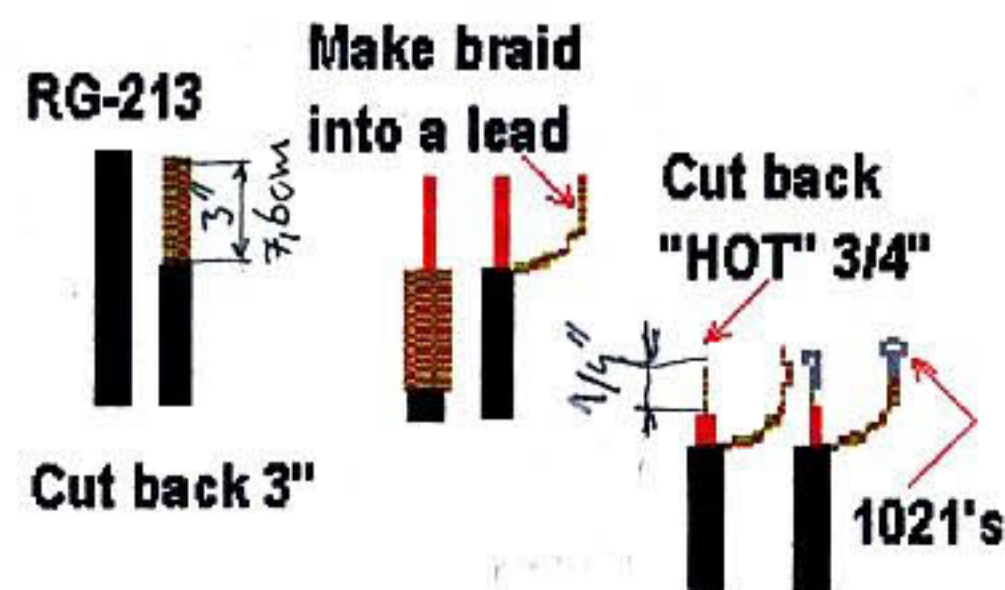

- < > Once the coax is in the form of a "Y", tape junction, (area where the coax stops and the two lines of the "Y" start), with a good 3-M type electrical tape. This will seal the coax from the weather.

- < > Cut the insulation on the "HOT" or center of the coax line, back 1/4" and solder one of the #1021 solder lugs to the exposed end of the center section of the coax.
- < > Before soldering the #1021 solder lug on the braided section, twist braid to ensure you have a good section of line.
- < > Solder #1021 solder lug onto the braided line. Be careful not to overheat the braid line to avoid the melting of the insulation covering the center section of the coax.
- < > Tape "Y" with a good 3-M electrical tape. Use several layers. This is the easiest and best method of securing joint

PLACEMENT OF COAX TO THE DRIVEN ELEMENT



- < > Locate the "Coax Mounting Screw" coming out of the radiator center assembly. (Note: That one screw is on aluminum tubing. This side is used for the braid connection.)
- < > Place one of the #1021 Solder Lugs onto the mounting screw, and secure with a lock washer and a 8-32 nut.
- < > After both leads are attached, secure the coax to the boom with tape. If a choke is being used, tape as shown in the section below "Use of an RF Choke". If a choke is not used, simply run the coax without the coil and tape the coax along the boom.

USE OF AN RF CHOKE

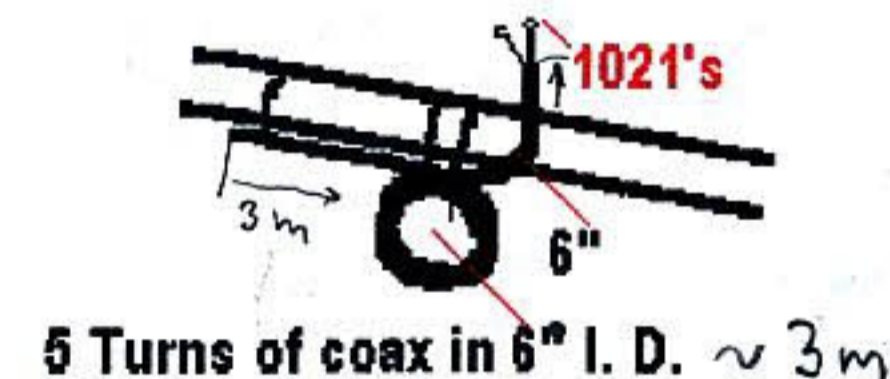

- < > If You want to, insert a R.F. Choke into the coax line to eliminate any RF on the coax line.
- < > To make the choke, coil the feed line (5 turns in a 6" inside diameter) right after the point where the coax attaches to the radiators center assembly. Make sure the coil starts within 3 to 6" from the attachment point. Tape the coil in three places to keep the coil in position and then tape the completed coil to the under side of the boom directly under the feed point at the center radiator section.

**(DO NOT USE A CAN OR FORM AND ROLL THE COAX WIDE ACROSS IT! THIS WILL CREATE A LARGE INDUCTOR AND NOT A RESONANT CHOKE!)**

- < > Position coax so that it won't pull on the driven element and will run toward the mast at the center of the tower. Don't forget to put in a turning loop of coax at the center of the tower, so the beam can freely rotate without pulling on the coax as the beam turns.

**Recheck All Connections**

- < > Make sure all hardware is tight and all color codes were followed.
- < > Make sure the penetrox was used.
- < > Place any remaining end caps or boom caps.
- < > Check the coax attachment points.

**Final Element Adjustments**

Once the antenna is ready to be tested, place the antenna on a temporary support 10 to 12 feet off the ground, away from surrounding objects.

- < > Run an SWR curve to see where the antenna is resonating. Determine if this is the areas you want the antenna to remain. If so permanently secure the BLUE radiator by drilling a hole into the 1/2" tube which is inserted in the 5/8" tubing on the BLUE inner element section.
- < > Use the existing drill hole in the 5/8" tubing as a "GUIDE" hole. Make sure you use a SMALLER drill bit so that the hole isn't oversized.
- < > Align the hole on the trapped element with the hole on the center assembly and secure with a single #6 stainless screw. (Remember not to over tighten the screw. Tighten only until the screw is flush with the outer tubing.)
- < > Tune in a signal on 20 meters and check the front to back ratio. If the front to back is acceptable then go ahead and secure the reflector and director in the same manner as was done with the radiator.
- < > If you would like to peek the front to back then you will need to adjust the reflector first then the director. The easiest way to do this is to remove the director traps, and work with the reflector until you have the desire ratio. (The adjustment shouldn't be more than 10" either way, e.g., longer or shorter.)
- < > When you have the reflector dimension, note the length and remove the reflector traps.
- < > Reinstall the director traps and adjust them for the least signal when point the back of the antenna at a signal source. When the maximum is obtained, secure with tape to the 5/8" tube.
- < > Reinstall the reflector. Check the SWR with all the elements back on the antenna with the new dimensions. (Remember that as you increase the front to back on this close spaced antenna the band width will DECREASE.)
- < > If the SWR and the front to back is where you want it, secure the trap elements in the same manner that was used on the radiator.

This completes antenna assembly. If you have any questions or need any help, please give us a call to our engineering department at 636-583-8595. Thanks for choosing Mosley!

## NOTES

These blank SWR charts are for your use and convenience.

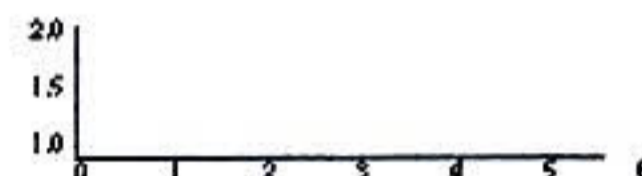

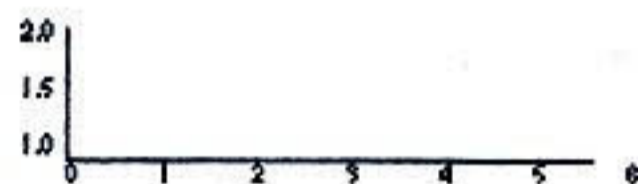
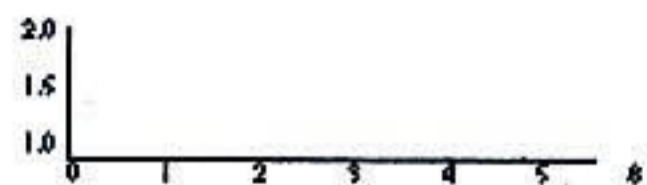

**Review**

The Mini-33-A was designed to give the Ham who would like to have a 3 element beam on "3" bands, but keep the size of the antenna smaller than even a normal tri-band antenna.

The design criteria was 1. A single feed line, 2. A very broad band capability, which will work with the new solid state rigs. 3. An antenna that was as compact as possible to justify its use on three bands. 4. To tune it for optimum gain for a "3" band beam on a 6' boom. 5. To minimize the interaction of the close proximity of the various bands. 6. Build it to withstand any above average environments.

The Mini-33-A has been tuned to give you as much flexibility as possible in an under sized beam.

There is one broad setting, however, a tuner can be used to make minor adjustments if needed. The antenna is very broad banded. The only restricted band is 10 meters. It is designed to be operated between 28,000 to 29,000, since this is the main area for HF work in SSB and CW.

We feel the Mini-33-A gives a Ham the best of all worlds in a very small package!

Enjoy!

**Average SWR Curves for the Mini-33-A**

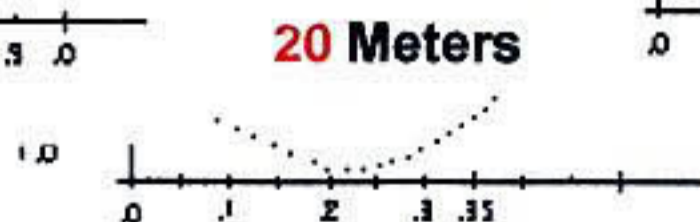
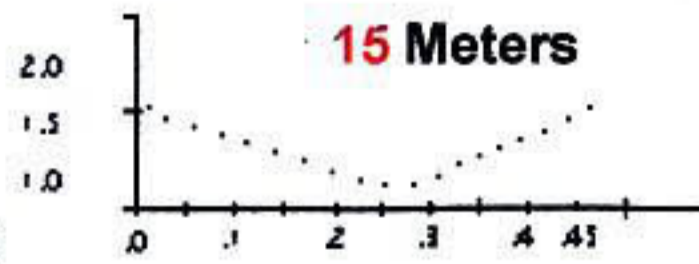
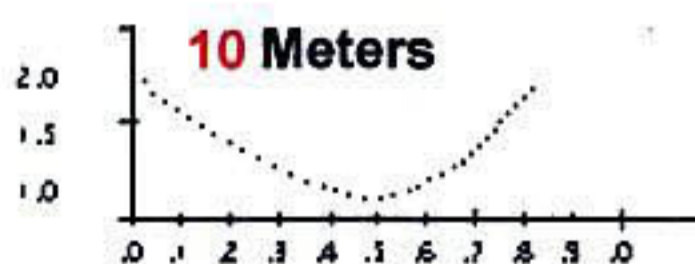

**SUGGESTIONS**

Before hauling your antenna all the way up a tower, check it at least 10 to 12 feet off the ground. In checking the antenna, **DO NOT put the reflector on the ground and point the antenna up in the air.** Place the antenna on a ladder, temporary pole, or to the side of your tower in a horizontal plane. This will enable you to get an over view of where the antenna is resonant. That is, if you're showing 2:1 everywhere, you have a problem. However, if you are seeing the antenna trying to dip, but not going completely flat and/or the frequency is 50 to 80 kHz. lower in the band; the antenna is correctly assembled. Remember at this low height you are coupling with ground. That can be both real ground and artificial ground.

Due to the high "Q" of the antenna it will couple with ground, artificial or real. This type of check will allow you to see that the antenna is trying to dip and does exhibit an SWR curve. However, due to it being near to ground, or other resonant objects, this curve can be shifted lower in frequency, and not totally flat or down to 1:1.

A problem with the assembly of the antenna would be indicated if all bands are showing in excess of 2:1 with no dip of any kind. A coupling problem would be indicated when only one or two bands are unusual and the remainder are within specifications.

**WATCH OUT FOR ARTIFICIAL GROUND**

Artificial ground is presented to an antenna through various means. Guywires up under the antenna, the roof top, other resonant antennas near by, are the most common causes.

This would cause a disruption of a few bands and also degrade the front to back ratio. As with any good antenna, it needs to have a clear area in which to perform.

The antenna should be at least a 1/4 wave length from any artificial ground at the lowest operating frequency of the antenna. In the case of the Mini-33-A, the lowest operating frequency is 20 meters or 14 MHz. With this in mind, the antenna should be at a minimum 17 feet away from any artificial ground. Remember this is a minimum. In a commercial installation, this minimum would be 1/2 wave length away.

To break up guy wires, use an insulator every 4' for the first 16', (4 insulators per leg), or use a non metallic guy. This will give a non resonant length under the antenna and will allow the antenna to perform as shown in our specifications. If these procedures are ignored, the antenna will still work very well, however, there will be some trade off in bandwidth, resonance, and front to back.

A high "Q" antenna needs to have a proper installation to get the most out of the system.

Doing these simple checks and following these basic rules concerning installation can save you and your crew a lot of frustration. If you think you have a problem, and would like to discuss your installation or something is going on you don't understand, please call us, 1-636-583-8595 we will be glad to help. We want you to be as happy as we are you chose MOSLEY!

Mini-33-A 12/99